

Product Summary

$V_R = 650\text{ V}$
 $I_F = 10\text{ A}$ ($T_C=154^\circ\text{C}$)
 $Q_c = 33\text{ nC}$ ($V_R=400\text{ V}$)

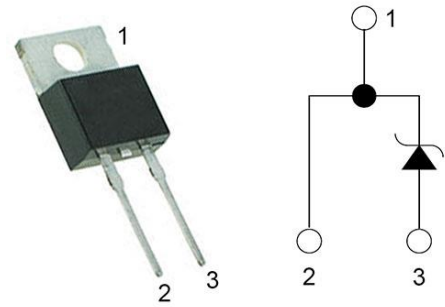

TO-220-2

Features

- Zero Forward/Reverse Recovery Current
- High Blocking Voltage
- High Frequency Operation
- Positive Temperature Coefficient on V_F
- Temperature Independent Switching Behavior
- High surge current capability
- 100% avalanche tested

Benefits

- Higher System Efficiency
- Parallel Device Convenience without thermal runaway
- Higher Temperature Application
- No Switching loss
- Hard Switching & Higher Reliability
- Environmental Protection

Applications

- Switch Mode Power Supplies
- Solar Inverters
- AC/DC converters
- DC/DC converters
- Uninterruptable power supplies

Maximum Ratings ($T_C=25^\circ\text{C}$ unless otherwise specified)

Parameter	Symbol	Test conditions	Value	Unit
Peak Repetitive Reverse Voltage	V_{RRM}		650	V
Peak Reverse Surge Voltage	V_{RSM}		650	V
DC Blocking Voltage	V_R		650	V
Continuous Forward Current	I_F	$T_C=25^\circ\text{C}$	34	A
		$T_C=135^\circ\text{C}$	15	
		$T_C=154^\circ\text{C}$	10	
Non repetitive Forward Surge Current	I_{FSM}	$T_C = 25^\circ\text{C}$, $t_p=10\text{ ms}$, Half Sine Pulse	76	A
		$T_C = 110^\circ\text{C}$, $t_p=10\text{ ms}$, Half Sine Pulse	70	
Repetitive peak Forward Surge Current	I_{FRM}	$T_C = 25^\circ\text{C}$, $t_p=10\text{ ms}$, Freq = 0.1Hz, 100 cycles, Half Sine Pulse	70	A
		$T_C = 110^\circ\text{C}$, $t_p=10\text{ ms}$, Freq = 0.1Hz, 100 cycles, Half Sine Pulse	60	
Total power dissipation	P_D	$T_C=25^\circ\text{C}$	120	W
Operating Junction Temperature	T_J		-55 to 175	$^\circ\text{C}$
Storage Temperature	T_{STG}		-55 to 175	$^\circ\text{C}$

Stresses exceeding those listed in the Maximum Ratings table may damage the device. If any of these limits are exceeded, device functionality should not be assumed, damage may occur and reliability may be affected.

Electrical Characteristics

Parameter	Symbol	Test conditions	Min	Typ	Max	Unit
DC Blocking Voltage	V_{DC}	$I_R = 250\mu A, T_J = 25^\circ C$	650			V
Forward Voltage	V_F	$I_F = 10A, T_J = 25^\circ C$		1.25	1.5	V
		$I_F = 10A, T_J = 125^\circ C$		1.33		
		$I_F = 10A, T_J = 175^\circ C$		1.43		
Reverse Current	I_R	$V_R = 650V, T_J = 25^\circ C$		2	80	uA
		$V_R = 650V, T_J = 125^\circ C$		7		
		$V_R = 650V, T_J = 175^\circ C$		25		
Total Capacitive Charge	Q_C	$V_R = 400V, T_J = 25^\circ C$		33		nC
Total Capacitance	C	$V_R = 1V, T_J = 25^\circ C,$ Freq = 1MHz		570		pF
		$V_R = 200V, T_J = 25^\circ C,$ Freq = 1MHz		62		
		$V_R = 400V, T_J = 25^\circ C,$ Freq = 1MHz		48		

Note: This is a majority carrier diode, so there is no reverse recovery charge

Thermal Characteristics

Parameter	Symbol	Condition	Min	Typ	Max	Unit
Thermal Resistance	$R_{th(j-c)}$	junction-case		1.25		$^\circ C/W$

Typical Electrical Curves

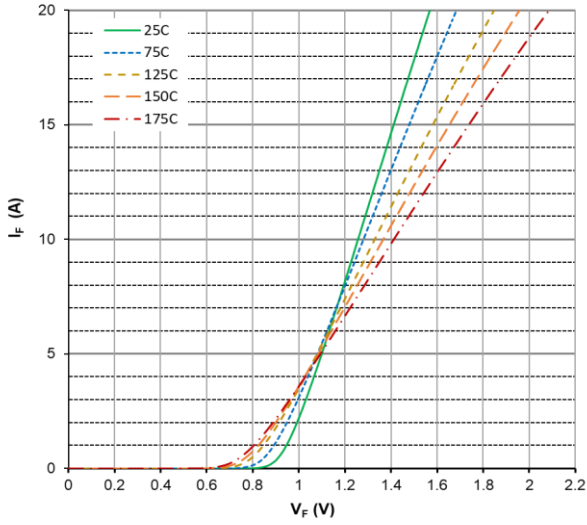

Figure 1. Forward Characteristics

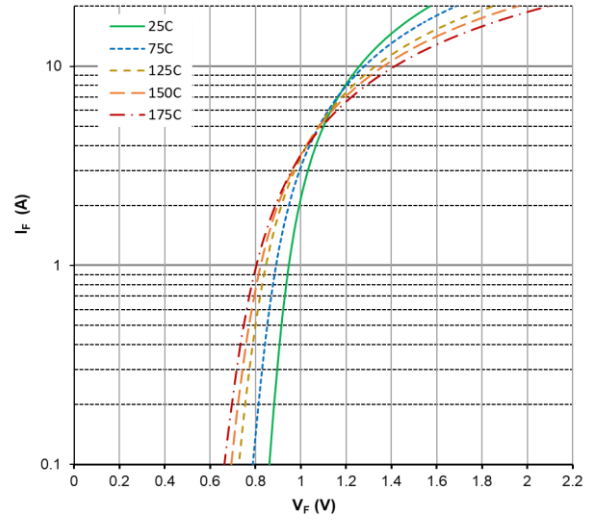

Figure 2. Forward Characteristics

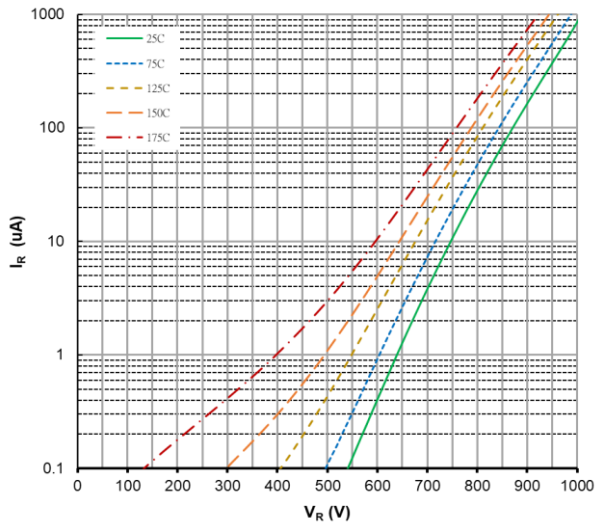

Figure 3. Reverse Characteristics

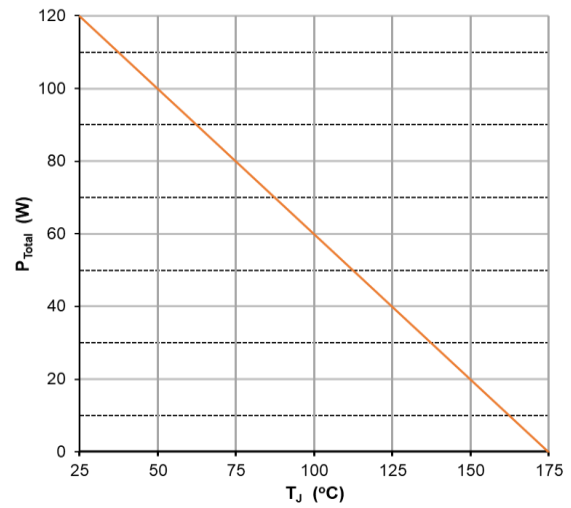

Figure 4. Power Derating

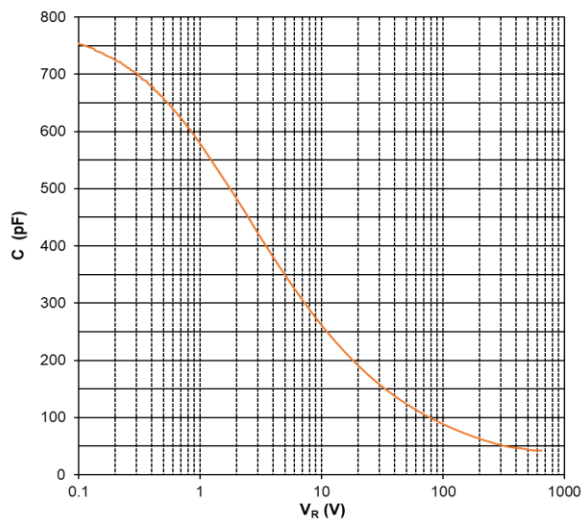

Figure 5. Capacitance vs Reverse Voltage

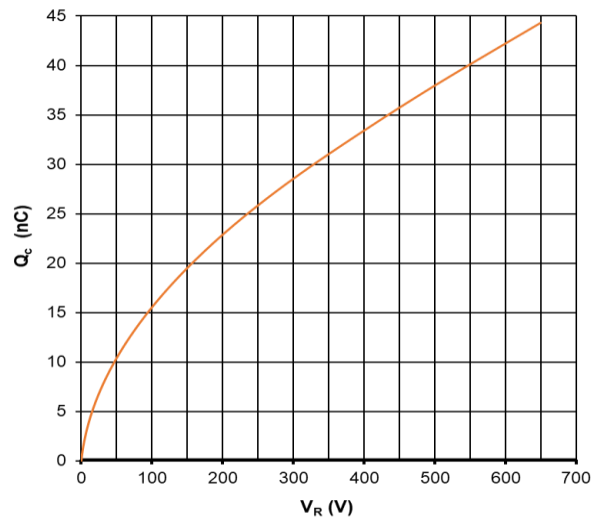
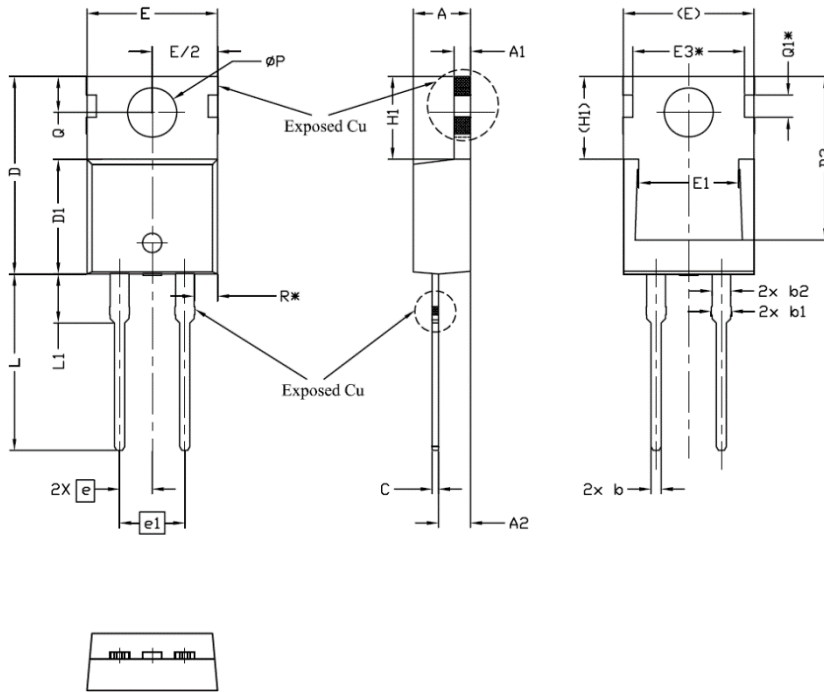

Figure 6. Capacitance Charge vs Reverse Voltage

Package Dimensions

(TO-220-2 Package)



SYMBOL	Dimensions		Notes
	MIN.	MAX.	
A	4.24	4.64	
A1	1.15	1.40	
A2	2.30	2.70	
b	0.70	0.90	
b1	1.20	1.75	
b2	1.20	1.70	
c	0.40	0.60	
D	14.70	16.00	4
D1	8.82	9.02	
D2	12.43	12.83	5
E	9.96	10.36	4, 5
E1	6.86	8.89	5
E3*	8.70REF.		
e	2.54BSC		
e1	5.08BSC		
H1	6.30	6.60	5, 6
L	13.47	13.97	
L1	3.60	4.00	
φP	3.75	3.93	
Q	2.60	3.00	
Q1*	1.73REF.		
R*	1.82REF.		

Note:

1. Package Reference: JEDEC TO220, Variation AB.
2. All Dimensions Are In mm.
3. Slot Required, Notch May Be Rounded
4. Dimension D & E Do Not Include Mold Flash. Mold Flash Shall Not Exceed 0.127mm Pre Side. These Dimensions Are Measured At The Outermost Extreme Of The Plastic Body.
5. Thermal Pad Contour Optional Within Dimensions E, H1, D2 & E1.
6. Dimension E2 & H1 Define A Zone Where Stamping And Singulation Irregularities Are Allowed.
7. "*" is reference .

Part Number	Package	Packing	Marking
ACD10HS065C	TO-220-2	50pcs / Tube	ACD10HS065C